

2.5系列/Group 2.5

2.5系列标准型产品概览/Group 2.5 Standard Product Overview

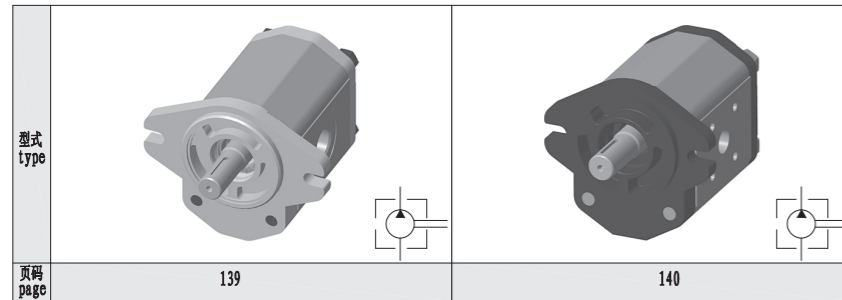

2.5系列排量参数表/Group 2.5 Displacement parameter table

排量 Displacement	V	cm ³ /rev	10	12.5	14	16	18	19	20	23	25	26.5	28	30	32	36	40	45		
吸油绝对压力 Suction absolute pressure	Pe		0.7...3																	
最高连续压力 Max. continuous pressure	P1	bar	250						230				200		160					
最高间隙压力 Max. intermittent pressure	P2		270						250				230		180					
最高峰值压力 Max. peak pressure	P3		290						260				250		200					
最低转速 Min. speed	n _{Min}	r/min	800		700		600		500				400							
最高转速 Max. speed	n _{Max}	r/min	4000				3500								3000		2750		2500	
容积效率 Volumetric efficiency	η _v	%	≥91		≥92		≥93				≥94				≥95					

2.5系列/Group 2.5

2.5系列流量性能曲线表/Group 2.5 Flow Performance Curve Table

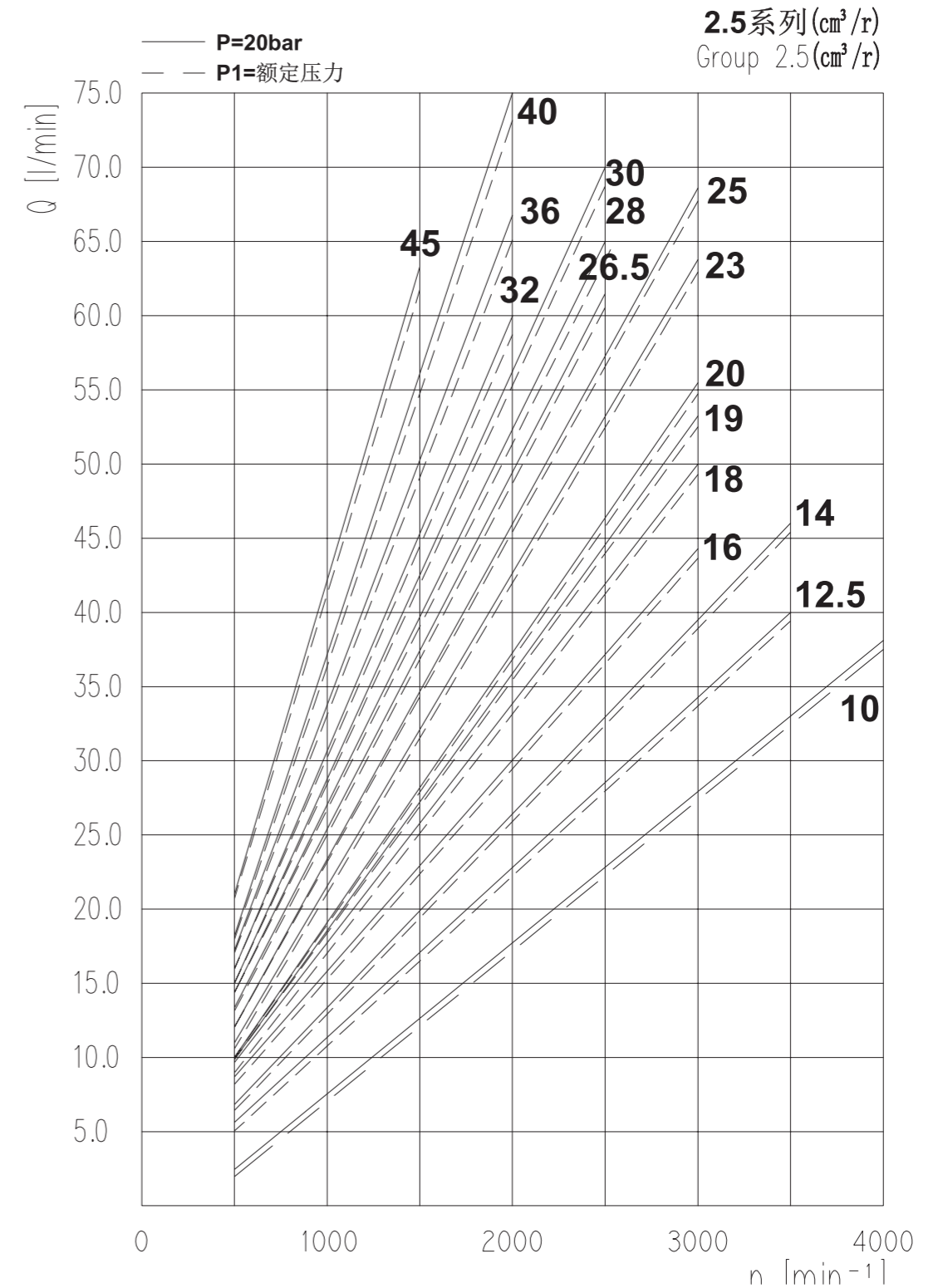

2.5系列/Group 2.5

2.5系列功率性能曲线表/Group 2.5 Power Performance Curve Table

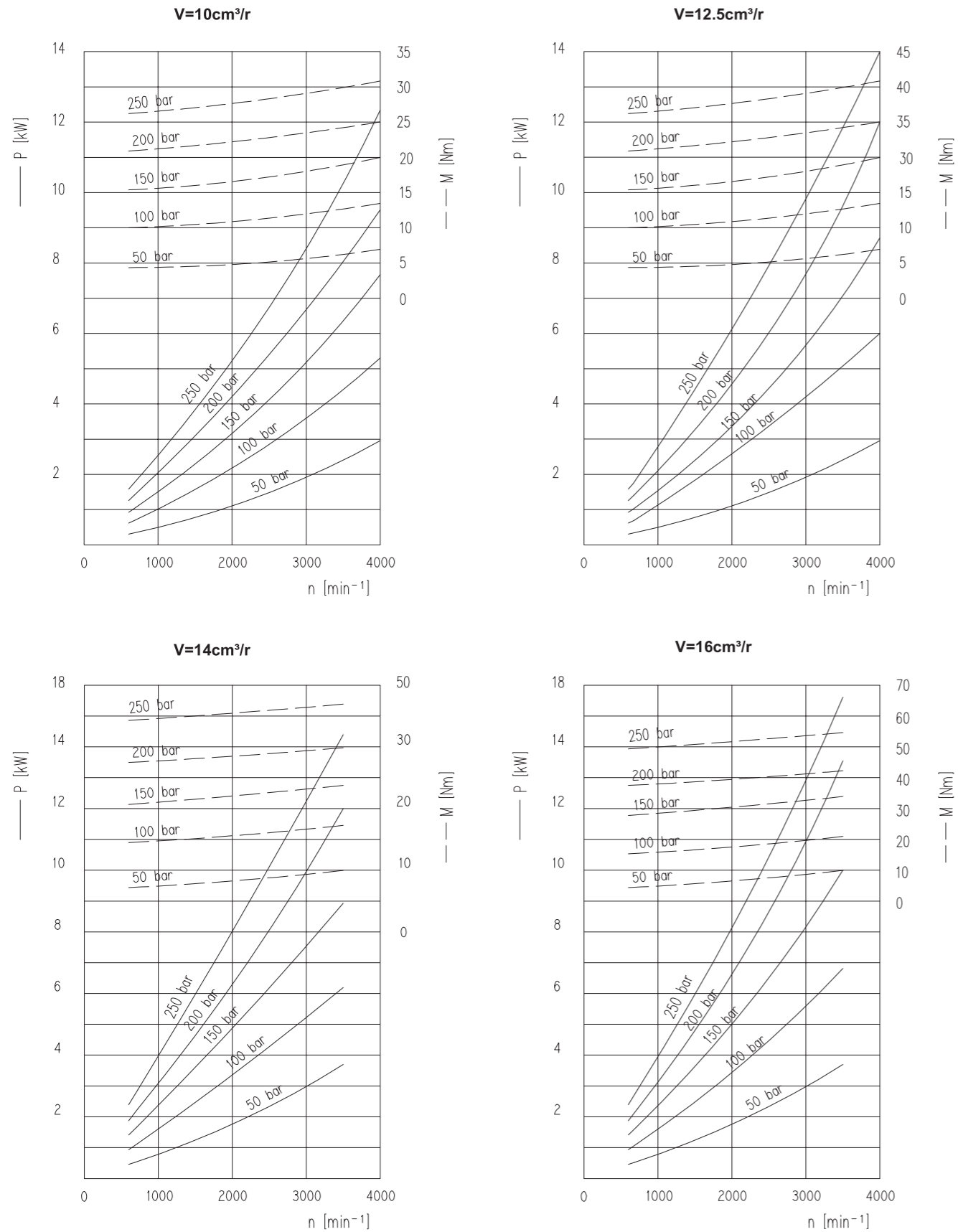

2.5系列/Group 2.5

2.5系列功率性能曲线表/Group 2.5 Power Performance Curve Table

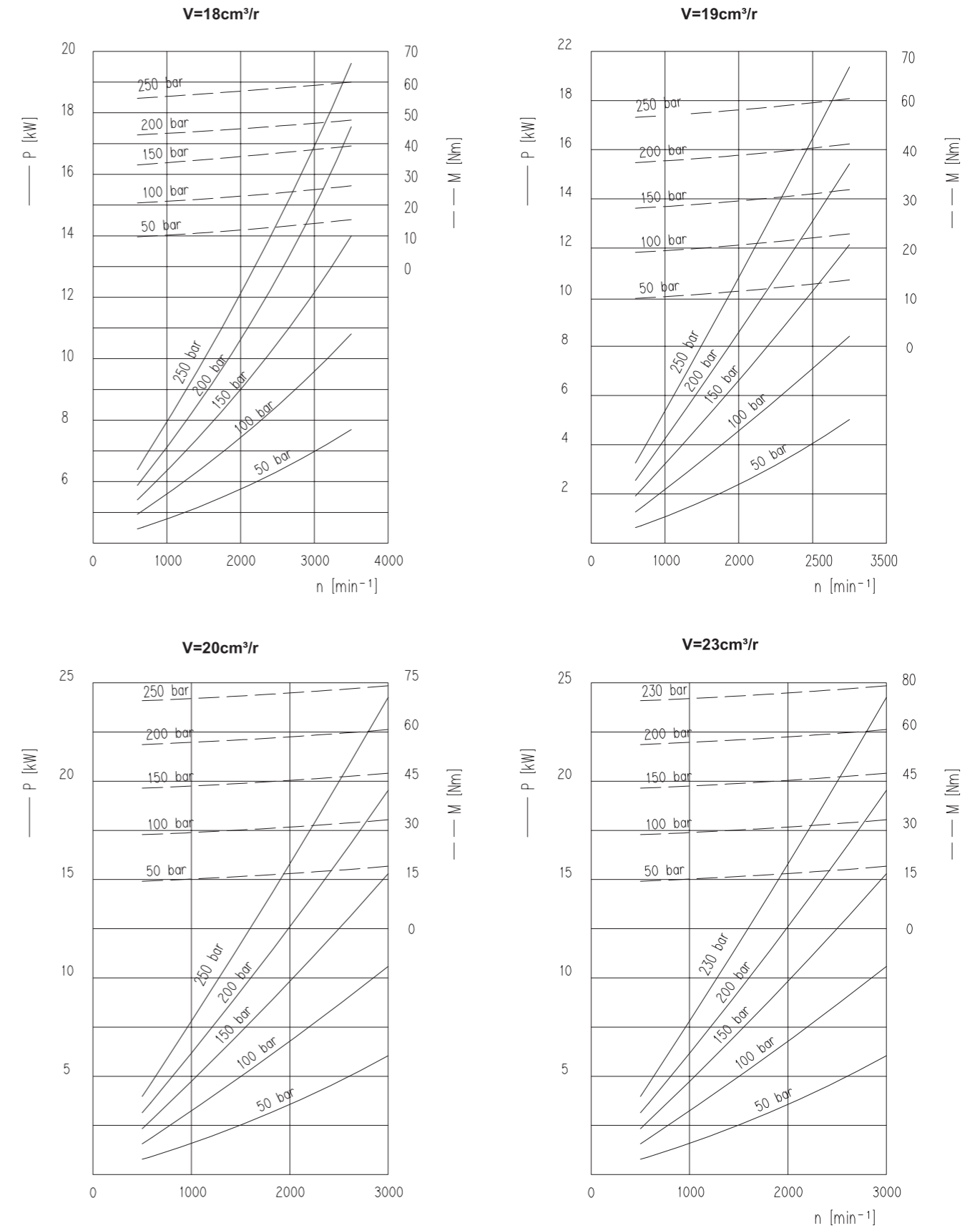

2.5系列/Group 2.5

2.5系列功率性能曲线表/Group 2.5 Power Performance Curve Table

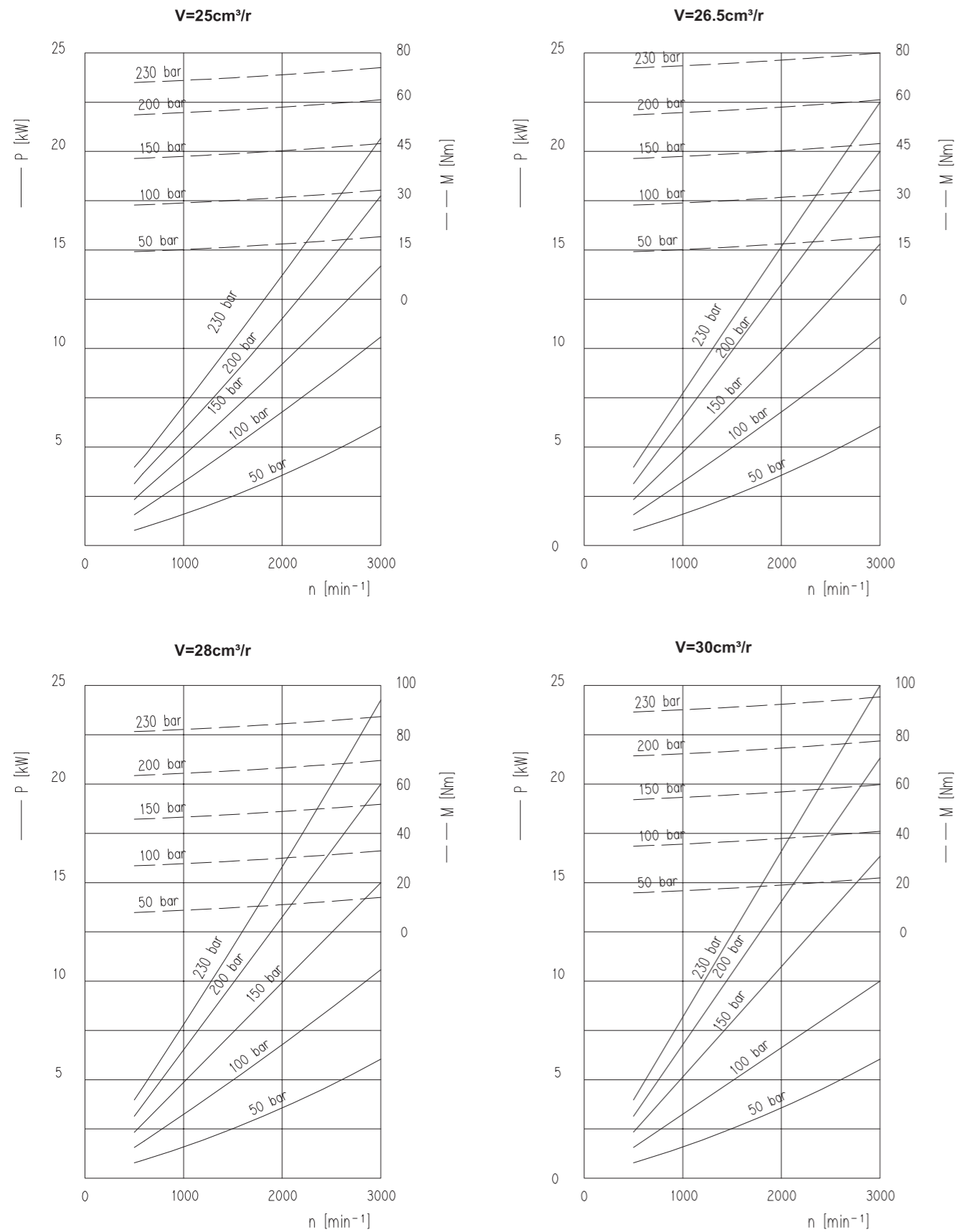

2.5系列/Group 2.5

2.5系列功率性能曲线表/Group 2.5 Power Performance Curve Table

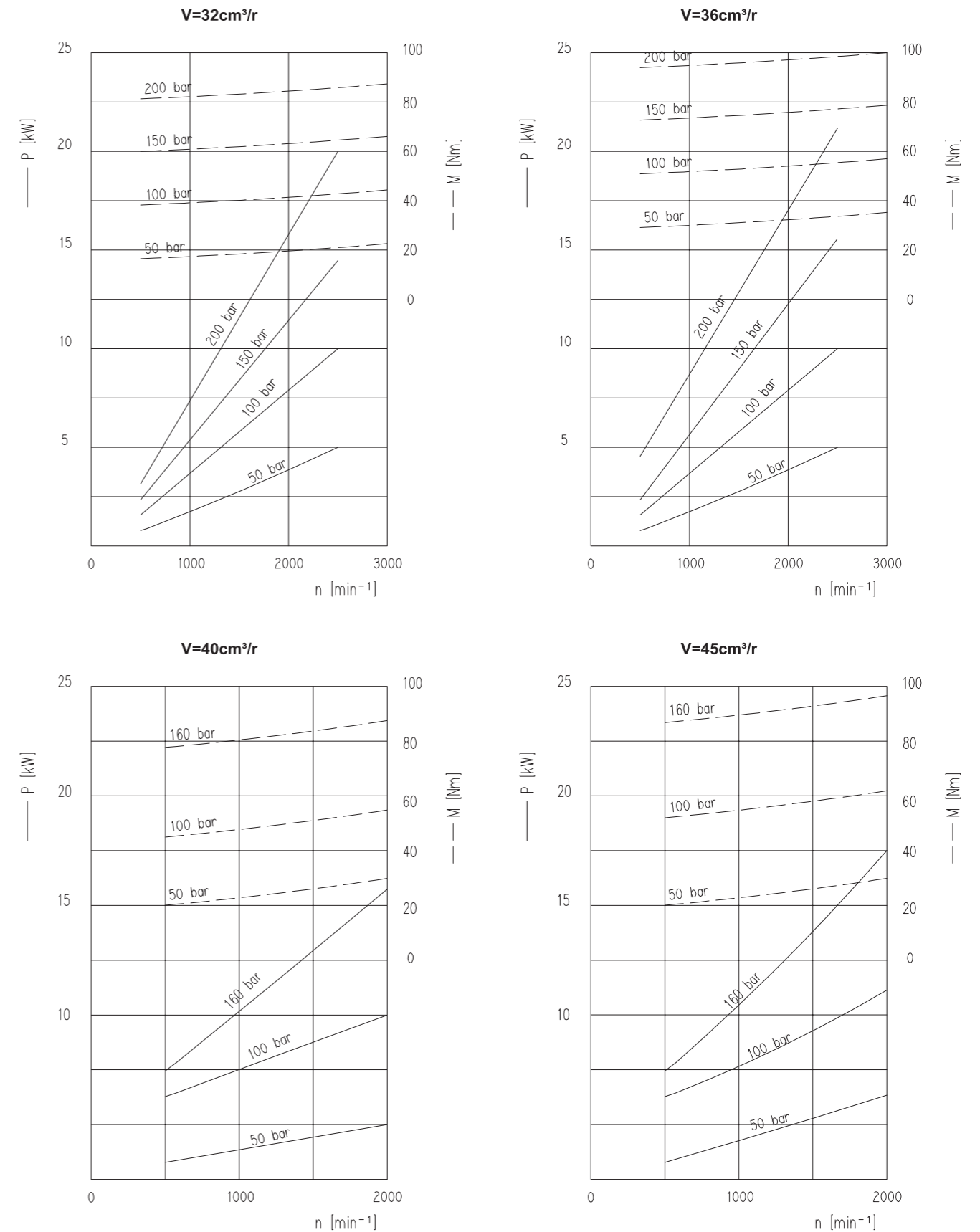

2.5系列/Group 2.5

2.5系列噪音曲线表/Group 2.5 Noise Curve Table

噪音曲线

噪音等级取决于转速和压力范围；这个压力范围介于10 bar和压力值 P1之间。

The noise level depends on the speed and pressure range; This pressure range is between 10 bar and pressure value P1.

油液数据: $v = 32 \text{ mm}^2/\text{s}$, $\theta = 50^\circ\text{C}$.

Oil data: $V = 32 \text{ mm}^2/\text{s}$, $\theta = 50^\circ\text{C}$.

对于从吸声测量室测得的噪音值进行计算而得到的声音压力等级，符合 DIN 45635 第 26 章的要求。

The sound pressure level obtained by calculating the noise value measured from the sound absorption measuring room meets the requirements of Chapter 26 of DIN 45635.

测量传感器与液压泵之间的距离: 1 米。

Distance between measuring sensor and hydraulic pump: 1m.

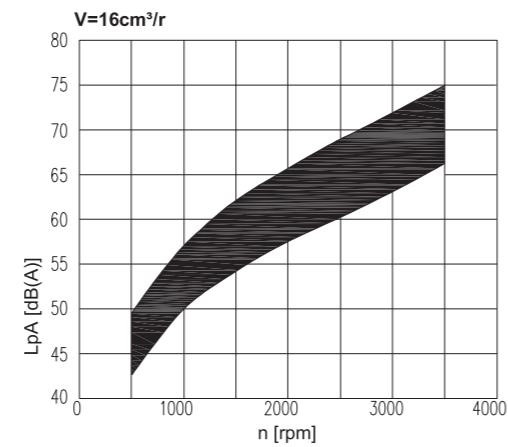
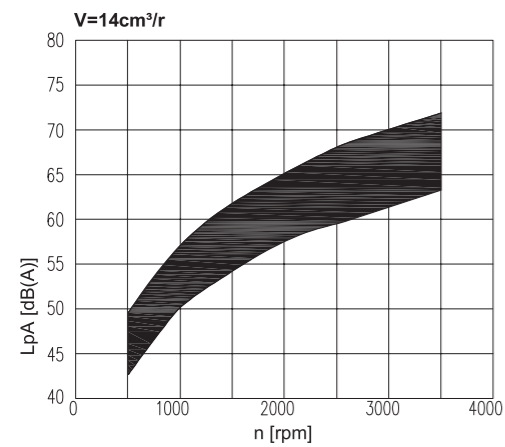
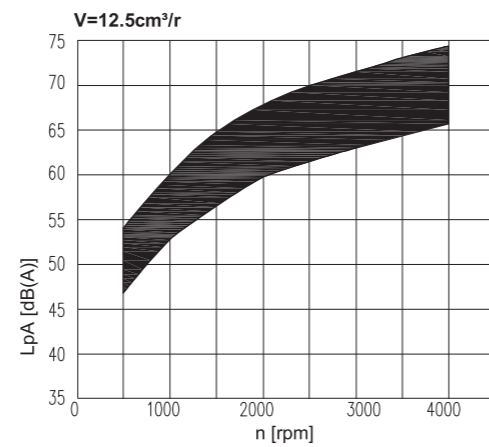
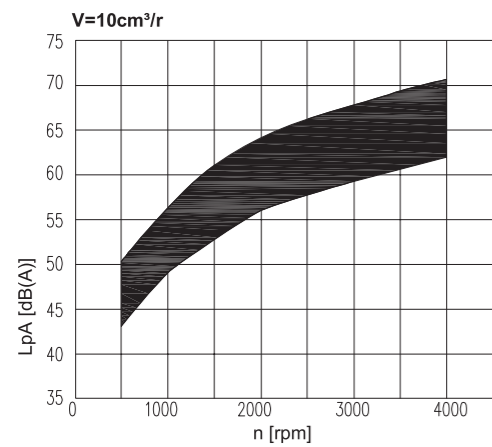

2.5系列/Group 2.5

2.5系列噪音曲线表/Group 2.5 Noise Curve Table

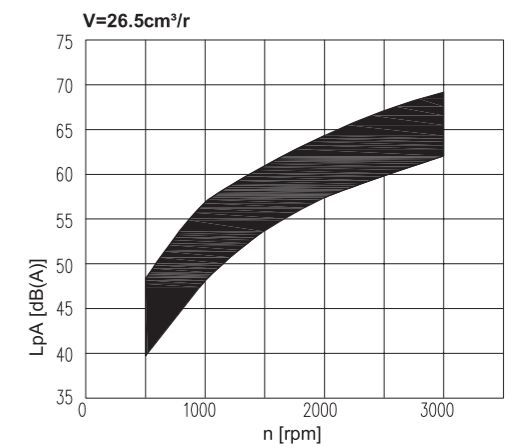
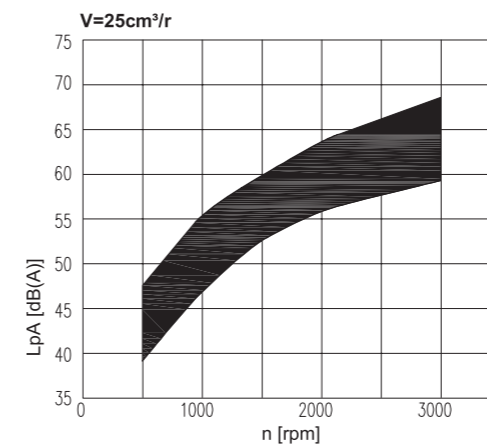
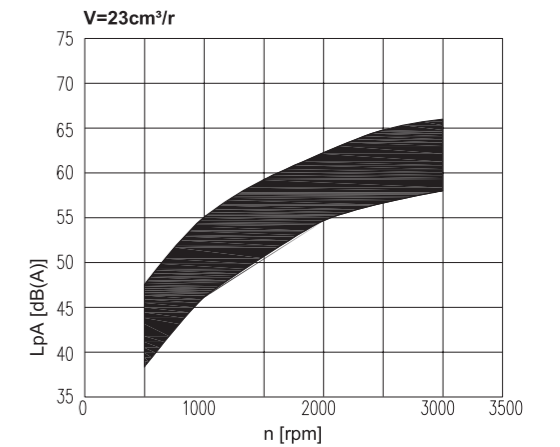
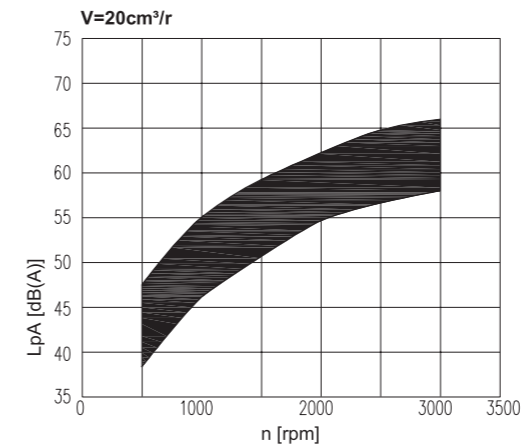
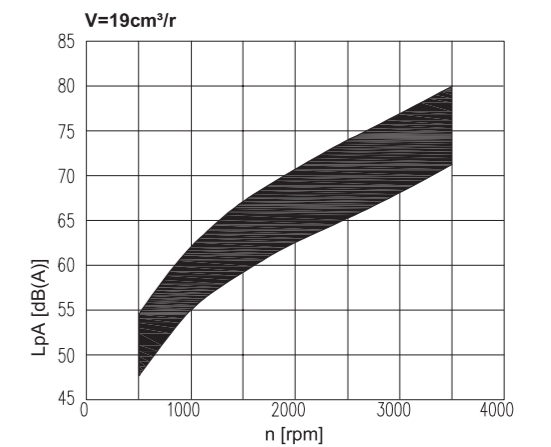
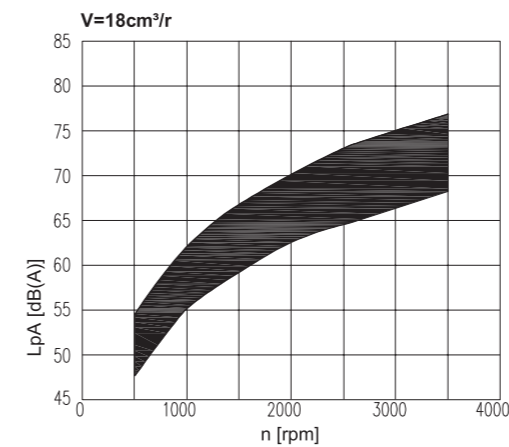

2.5系列/Group 2.5

2.5系列噪音曲线表/Group 2.5 Noise Curve Table

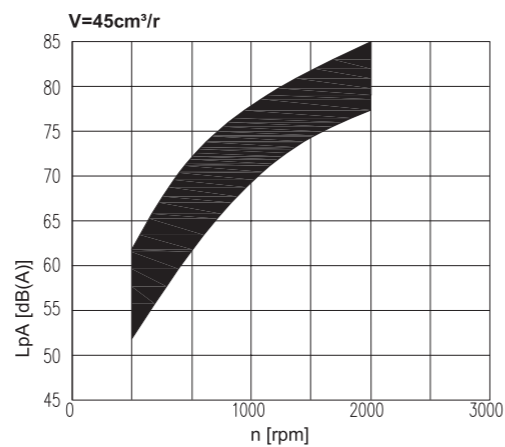
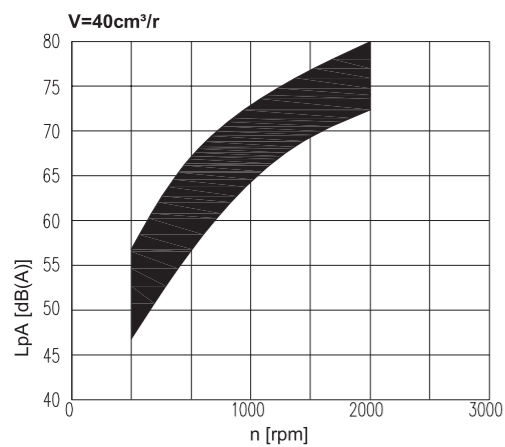
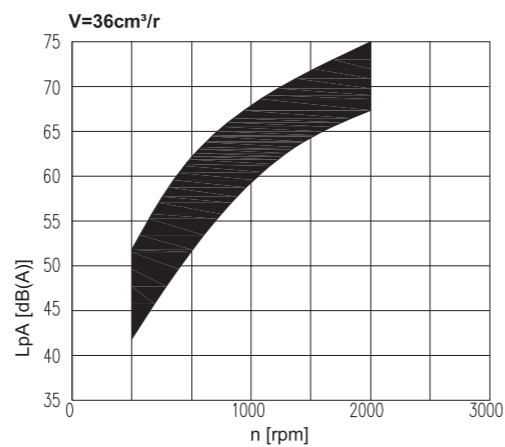
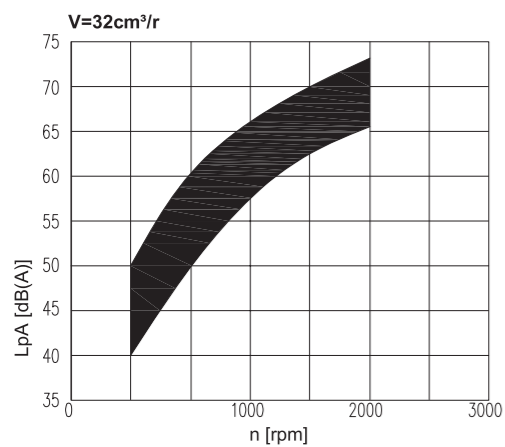
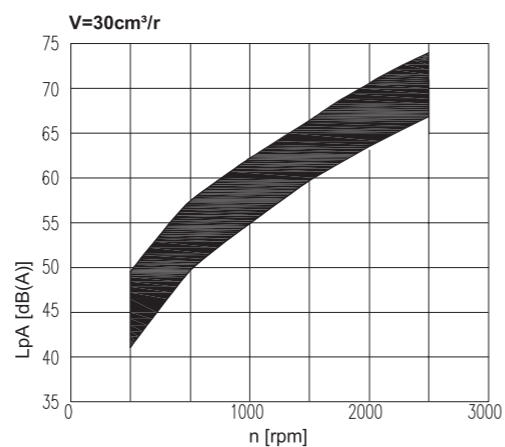
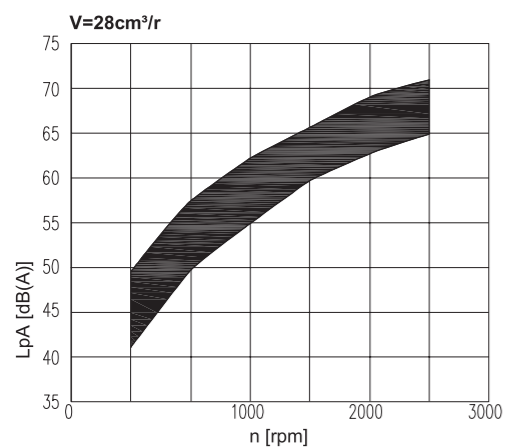

2.5系列/Group 2.5

前盖/Front COVER

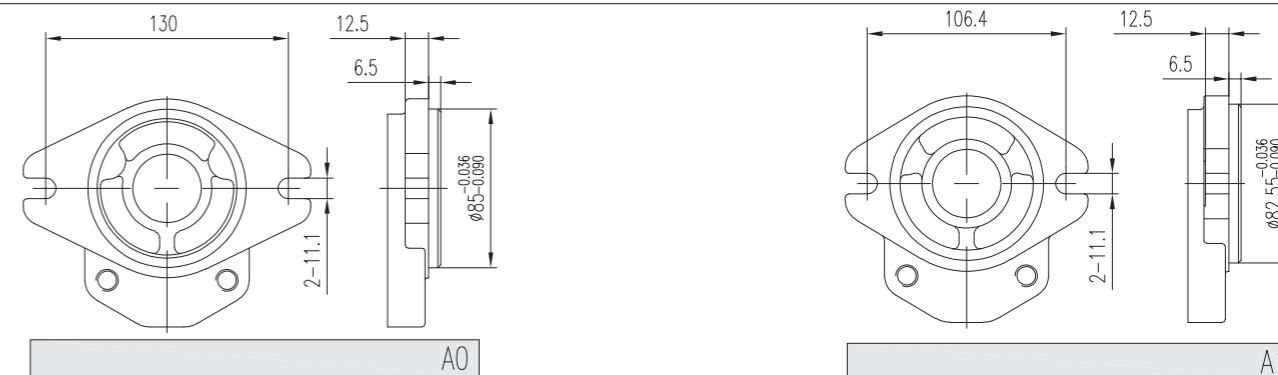

轴伸/SHAFTS

